



pearl



### “Pearl is the new White”

Pearl has been introduced in response to the changing needs of the commercial office environment. With white endcaps and fascias in a white body, Pearl reflects the predominant colour scheme of contemporary furniture – silver/grey frame with white worksurfaces

Pearl has, like the full range of Office Electrics products, been designed to allow soft power cabling, soft data cabling and soft fixing on-site. In addition, Pearl features our NEW front mount half-gang fascia which, can not only be factory fitted with data or AV connectors but also, allows: faster; simpler; and more cost effective addition/removal/change of data on-site – a further step towards Office Electrics’ goal of allowing the customer ‘soft-choice’ on-site.



Used in conjunction with underdesk units and appropriate cable management components, Pearl provides a total solution for power and data connectivity at the workstation, assisting with the requirements of the Disability Discrimination Act (DDA) by providing easily accessible facilities.

Taking up minimal space on the desk, or even hung from a screen or toolrail, Pearl is the perfect way to achieve compliance with the requirements of the Electricity at Work Act through compliance with BS6396 – whilst complementing the modern workspace.



office electrics

1 Calder Point, Monckton Road Industrial Estate,  
Wakefield, West Yorkshire, WF2 7AL  
Tel: +44 (0) 1924 367255 Fax: +44 (0) 1924 290652  
Email: sales@office-electrics.co.uk www.office-electrics.com

Elsafe, Unit 1, 17 Rodborough Road,  
Frenchs Forest NSW 2086, Australia  
Tel: +61 2 9454 7515 Fax: +61 2 9454 7505  
Email: sales@elsafe.com.au www.elsafe.com.au

## Common Modular Components\*

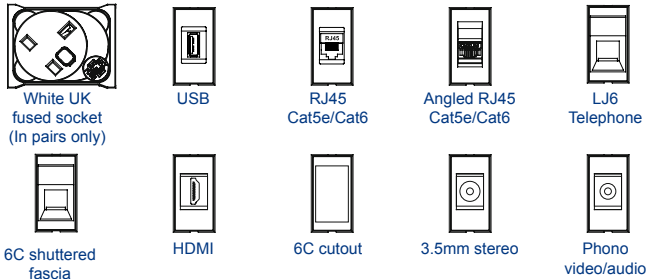

## Standard Unit Lengths

pearl 25/...

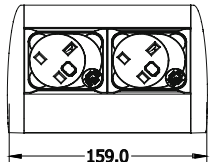

pearl 50/...

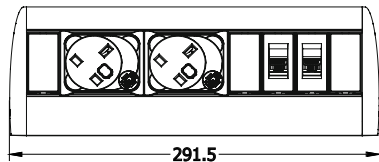

pearl 75/...

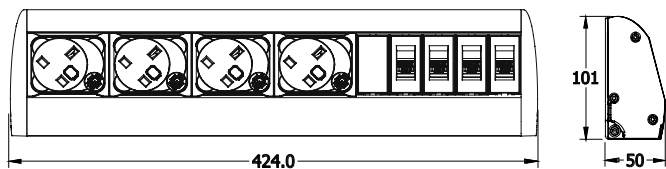

## Standard Fixings (in grey unless otherwise specified)

- CBV Vertical Clamp Bracket 13 - 40mm
- CBV-E Vertical Clamp Bracket (Extended) 25-55mm
- CBH Horizontal Clamp Bracket 20 - 35mm
- FTL Stick down fixing (Horizontal)
- TFB<sup>+</sup> Top Fix Bracket (Horizontal)
- EB Eared Bracket (Vertical)\*
- TRS Tool rail fixing (Vertical)\*
- RF Rubber feet (Horizontal)

\*Please call to confirm screen/toolrail compatibility

<sup>+</sup>TFB fixing is not 'soft' and cannot be changed on-site

## Horizontal

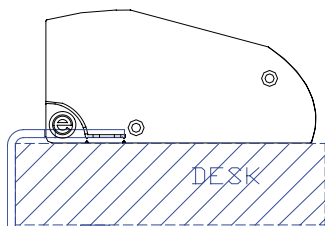

### CBH - Horizontal Clamp Bracket

Desk Clamp available for desks with a thickness between 20 and 35mm

Custom brackets available on application

## Screen Fixing

Screen/toolrail fixings can be provided to suit most applications - call our technical team for advice on which to use

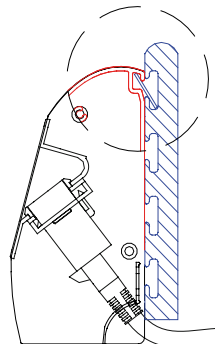

Angled data fascias allow data cabling to pass straight through PEARL, ensuring the integrity of cables which have a minimum bend radii (CAT5e, CAT6, etc)

## Vertical

### CBV - Vertical Clamp Bracket

Vertical clamps are available for desk thicknesses between 13mm and 55mm

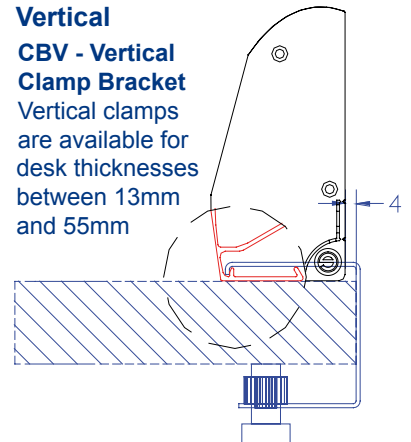

## Features

### Configuration:

Power only / Data only / Combined (Power & Data/AV)  
Internal segregation between Power and Data/AV in combined PEARL units

### Earthing:

Earthing is available from an earth slot in the rear of the unit to allow bonding to furniture (in accordance with BS6396). Earth leads are available on request.

### Fusing: (to enable compliance to BS6396)

5 x 20mm anti-surge ceramic fuses, with colour-coded fuseclips to denote the rating (3.15A/5A)

**Increased flexibility** - All PEARLs are supplied with cables exiting the rear. However, side exit facility is available on all vertical units through a snap-out endcap. Side exit choice can be taken on site and does not require disassembly of PEARL

### Security:

ANTI-FLEX system: Unique full length locking system guarantees unit integrity regardless of length

### Testing:

100% testing - continuity, polarity, insulation & earth

### Soft Wiring (power)

Power hardwired to Wieland ST/GST connector allows starter cables to be changed to suit requirements, especially useful during moves and changes (CHURN)

### Soft Wired Data

As well as soft-wired power, PEARL can accommodate soft wired data. Using our inline couplers, data cables can be changed "on-site" to accommodate changes in length often associated with churn

### Soft Fixing

PEARL is designed to allow brackets to be changed on-site. Unless stated otherwise, PEARL can simply be moved (using the same brkt) or attached to another feature on the desk simply by changing the bracket

